

OT900

BATTERY-POWERED ELECTRIC TUG
TO PULL LOADS **UP TO 3000 KG***

ZERO EMISSIONS

QUIET

LOW MAINTENANCE



Folding and height adjustable tiller for better comfort of use



Butterfly accelerator, easy to control with your thumb



Battery charger on board, display with light indication of charge status



Pivoting wheel allows a minimum of space to steer



The OT-900 is a towing equipment, with three wheels and tiller steering. It has been designed to easily move trailer trolleys and other containers on wheels, in safety and comfort, reducing physical stress and improving productivity. Many configurations are possible by choosing among different types of batteries and tires. It can be fitted with several accessories that make the standard product adaptable to many uses.

ALITRAK[®]
ELECTRIC MINDED

www.alitrak.com

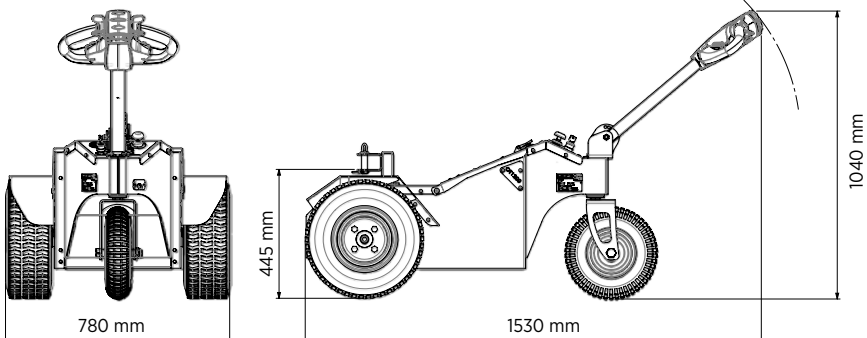

ALITRAK[®]
ELECTRIC MINDED
www.alitrak.com

FEATURES

Equipment body	3 wheels
Driving wheels on differential	Garden type
Driving control type	Foldable tiller
Accelerator	Butterfly type
Hook height	430 mm abt
Battery charger	On board, 13 A High Frequency
Dashboard display	Remaining battery charge
Parking brake	Electromagnetic with the possibility of release
Batteries	Flooded 2 x 12V/72 Ah C20 (or AGM 2 x 12V/85 Ah C20)
Elektromotor OT900	24V/900 Watt S1
OT1200	24V/1200 Watt AC S2 60 min
Product net weight	178 kg abt

PERFORMANCES



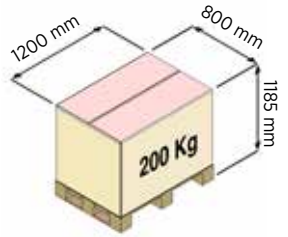







Weight movement capacity on flat surface up to*	3000 Kg
Pulling speed	
Fast	5 Km/h abt
Slow	2,5 km/h abt
Pushing speed	
Fast	3 Km/h abt
Slow	1,5 Km/h abt
Battery recharging time	8 hours abt



*The weight movement capacity is an indication., that can change with different machine fittings and working conditions (type of ground,wheel type,use of ballast,etc.)

Features shown are subject to change without notice

ACCESSORIES

- 
Anti dumping wheel frame with additional hook heights
- 
Direct steering system
- 
Clamp for trailer trolleys
- 
Squared tube hook
- 
Trailer mount and ball
- 
Different hook types
- 
Ballast 24 Kg
- 
Flashing light
- 
Different tyres and tread profiles
- 
Anti flat tire treatment by polyurethane filled wheels
- 
Different battery types